

Die EKOFLEX bietet Entwicklung, Konstruktion und Fertigung aus einer Hand.

EKOFLEX GmbH

Westring 22, 33142 Büren

+49 2951 9380 796

[www.EKOFLEX.de](http://www.EKOFLEX.de)



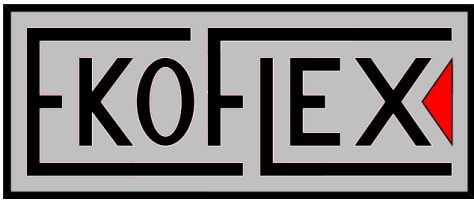

# EKOFLEX – Konstruktion

- Individuelle Beratung und Planung
- Anlagentechnik und Optimierung/Anpassung
- Sondermaschinen
- Werkzeugbau

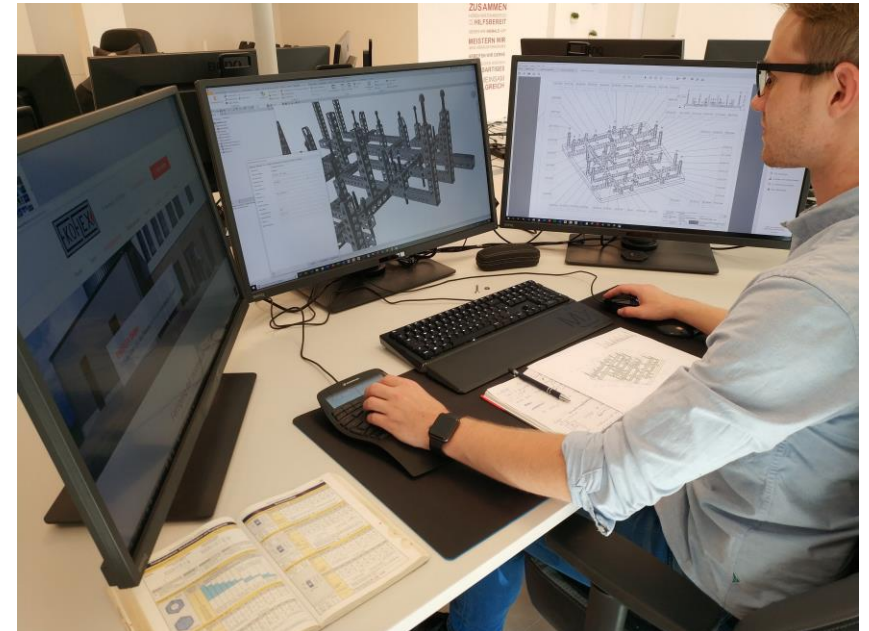

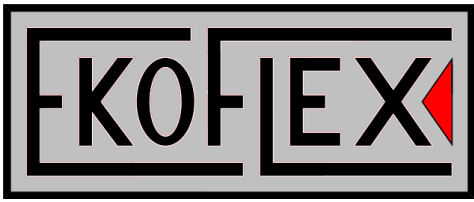

# EKOFLEX Fertigung

- Lohnfertigung

- 2½/3D-Fräsen
- Schweißen (WIG)
- Montage

## Partnerunternehmen

- Drehen
- Rohrlaser/Blechlaser
- Wasserstrahlschneiden
- Abkanten
- Lasersintern

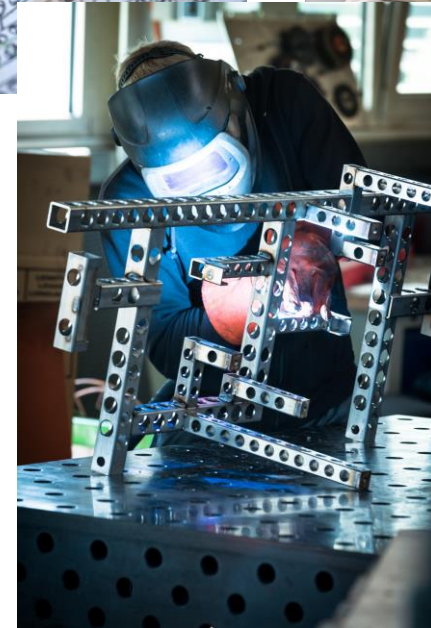
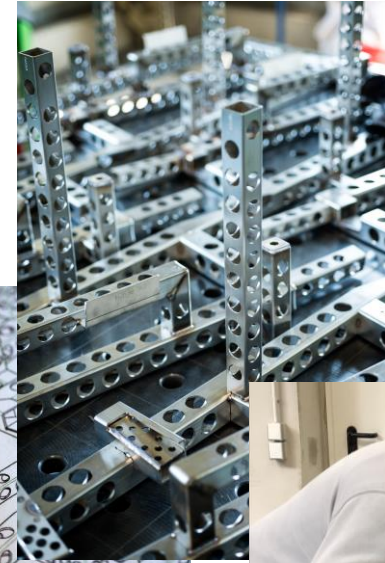
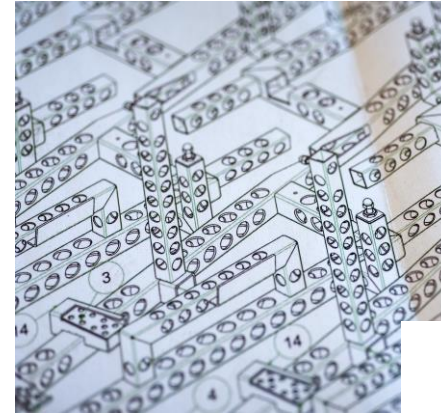

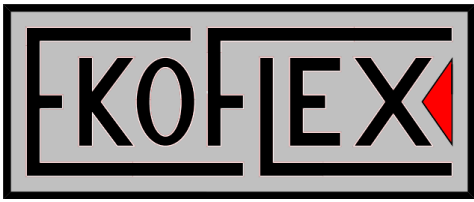

# EKOFLEX – 5-Achsfräsen

## Dimensionen - C400 Hermle

- Verfahrweg: 850 mm x 700 mm x 500 mm
- Körper:  $\varnothing 650$  / H 500
- Störkreis:  $\varnothing 885$  mm
- Maulweite: max. 625 mm

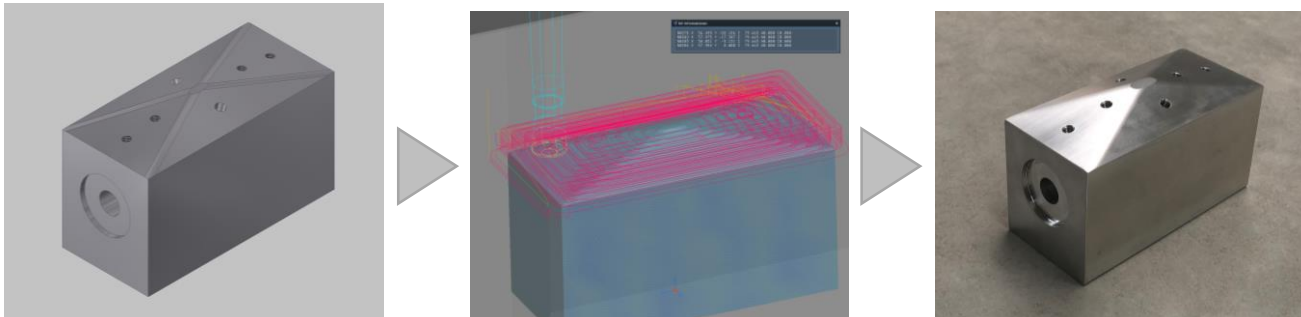

Programmierung mit Tebis®



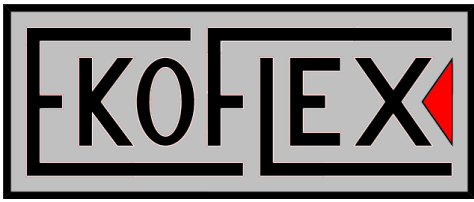

# Fertigungssystem

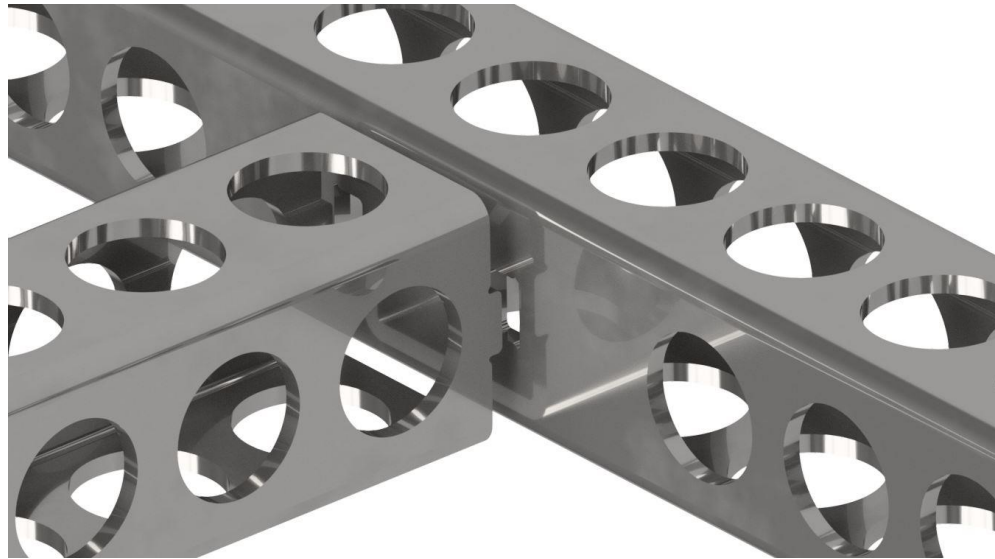

Konstruktionen werden als Stecksystem geplant und aus Laserzuschnitten gefertigt.

- + hohe Fertigungsgenauigkeiten
- + gleichbleibende Qualität
- + kostengünstige Fertigung
- + schnelle Fertigung

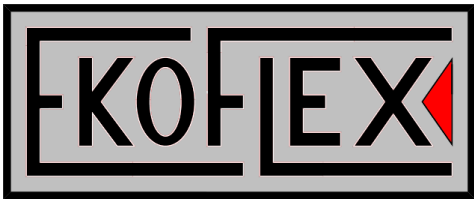

# Ansprechpartner



Sven Hindemith  
Geschäftsführer

+49 170 8353 729  
SvenHindemith@ekoflex.de



Pascal Lückenotto  
Projektmanager

+49 151 2298 6813  
PascalLueckenotto@ekoflex.de



Dominik Grimm  
Leiter Zerspanung / CAM Programmierung

+49 176 8783 6098  
DominikGrimm@ekoflex.de

